

Airtech/Speck Liquid Ring Vacuum Pumps are ideal for various applications that require continuous and quiet operation, compact design, and reduced power consumption. The single stage design provides efficient operation from 15 through 1100 cfm for vacuum levels up to 26" HgV. The impeller's unique design of slower spinning curved blades reduces tip speed enhancing the life expectancy of the pump.

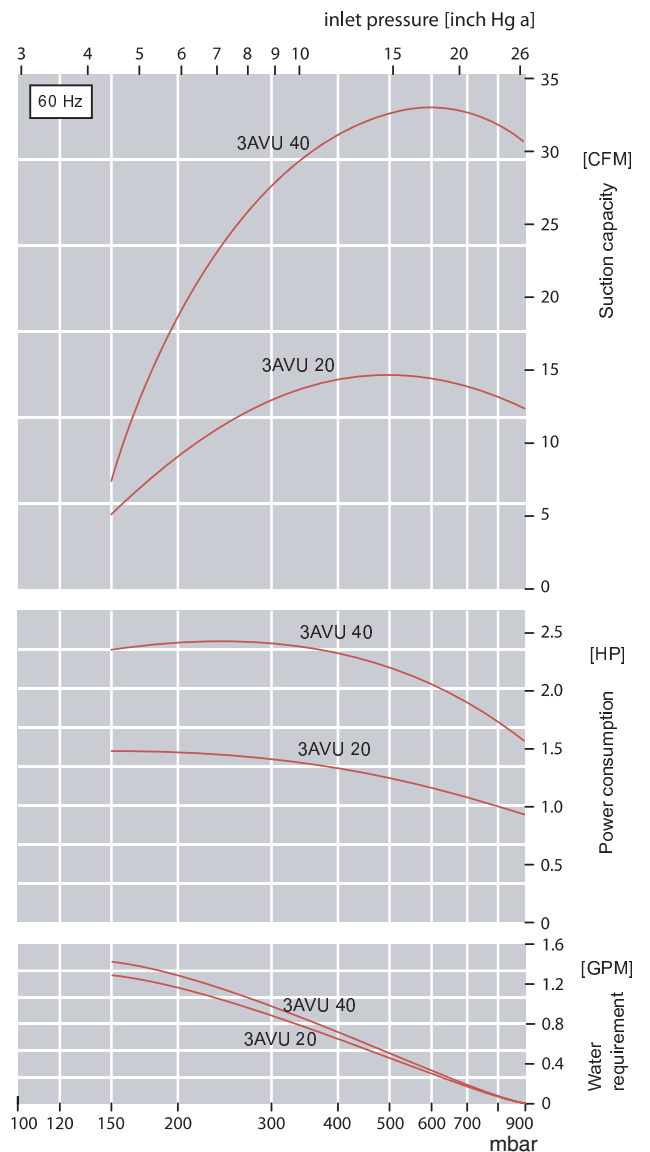

Dimensions: (inches)

3AVU 20

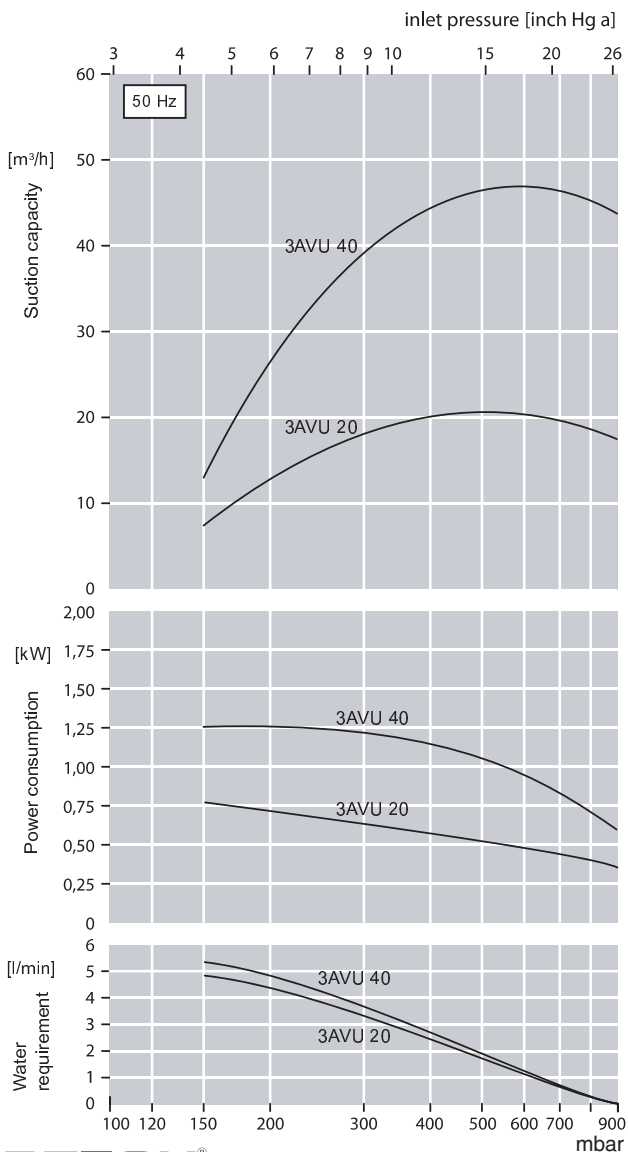
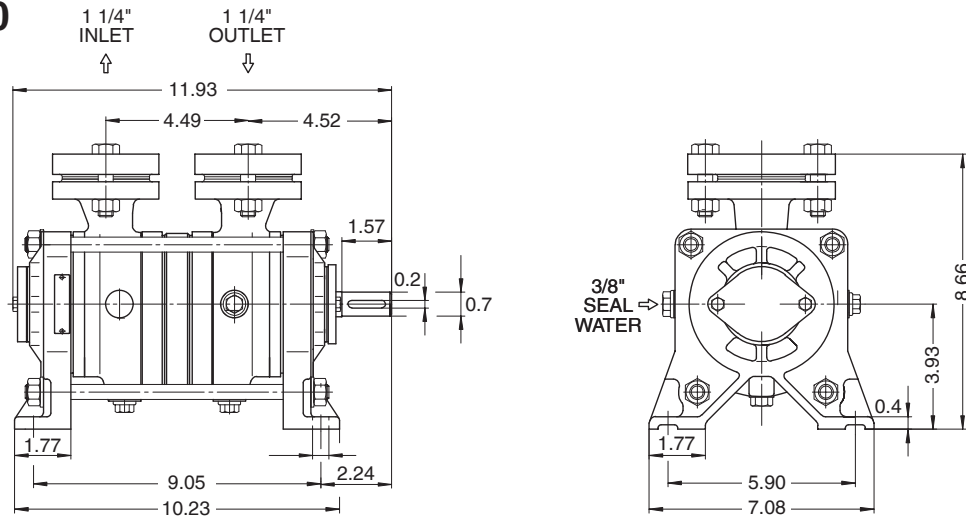

3AVU 40

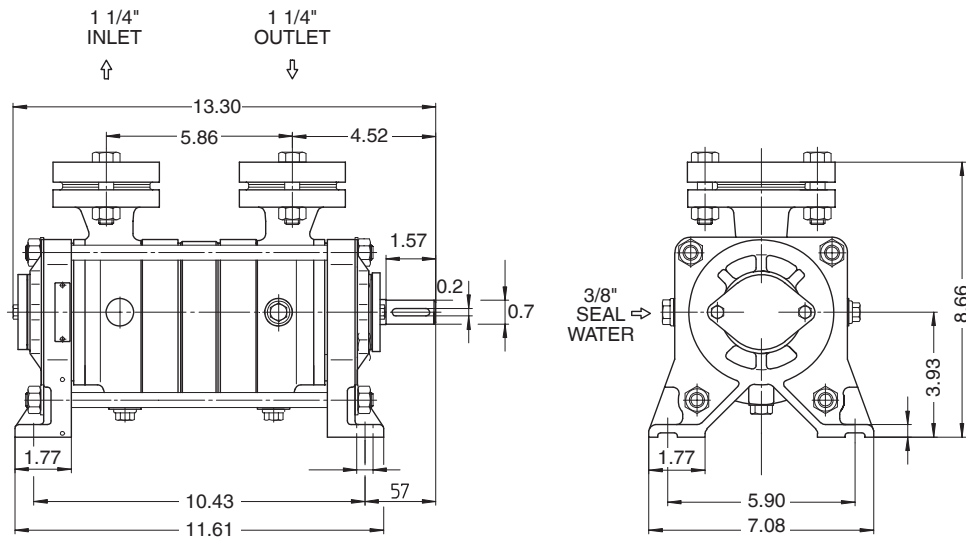

The characteristics are applicable for compression of 20° C (68° F) dry air from inlet pressure to atmospheric pressure (1013 mbar / 30 inch Hg a) for nominal speed and drive with three phase motors. Ring liquid is water at 15° C (59° F). The tolerance of the suction capacity is -10% and of the power consumption is +10%. With different operating conditions characteristic curves change (e.g. differing gas operating liquid conditions, conveying of additional liquids and/or pumping of gas-steam mixtures).