

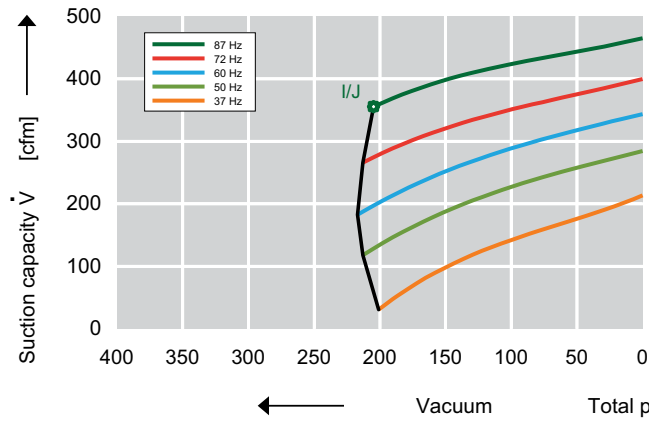

Features:

- Cooler running, outboard bearing provides maintenance-free operation
- Environmentally friendly oil-free technology
- Extremely quiet operation
- All motors are standard TEFC with Class F insulation, UL recognized, CE Compliant
Explosion-Proof motors available
- Custom construction blowers are available
- Rugged die-cast aluminum construction

Performance Curve for Vacuum



Performance Curve for Compressor

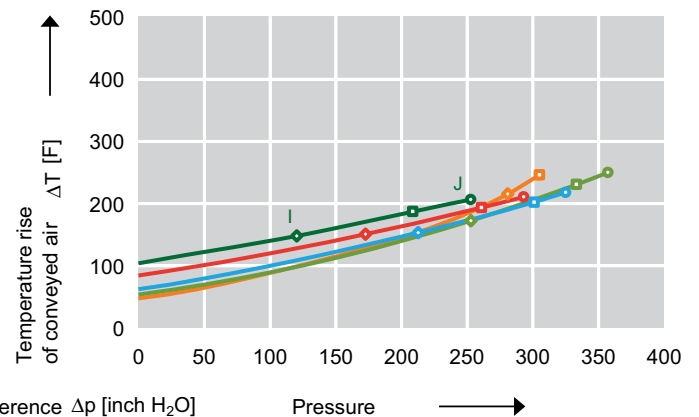
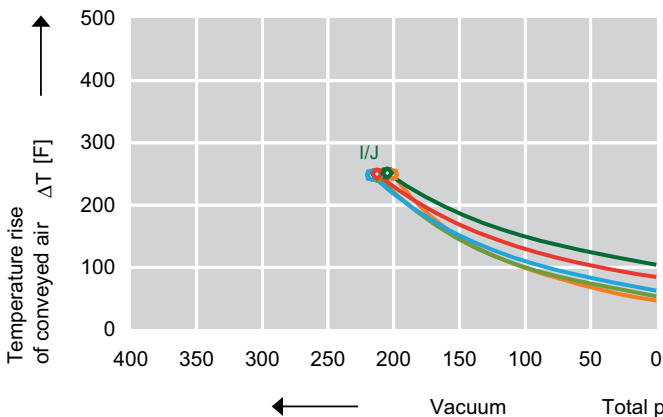
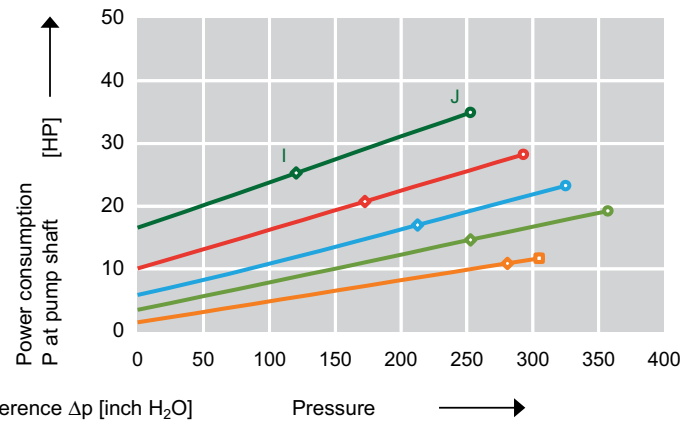
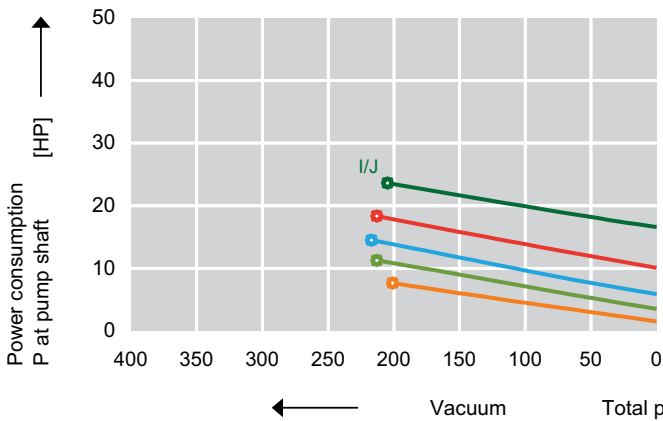
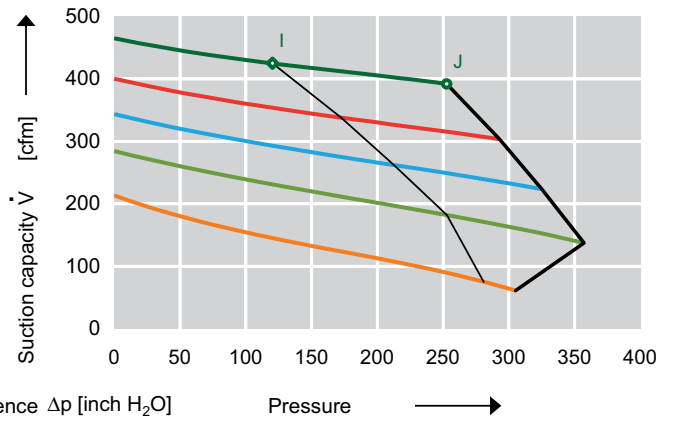

Dimensions

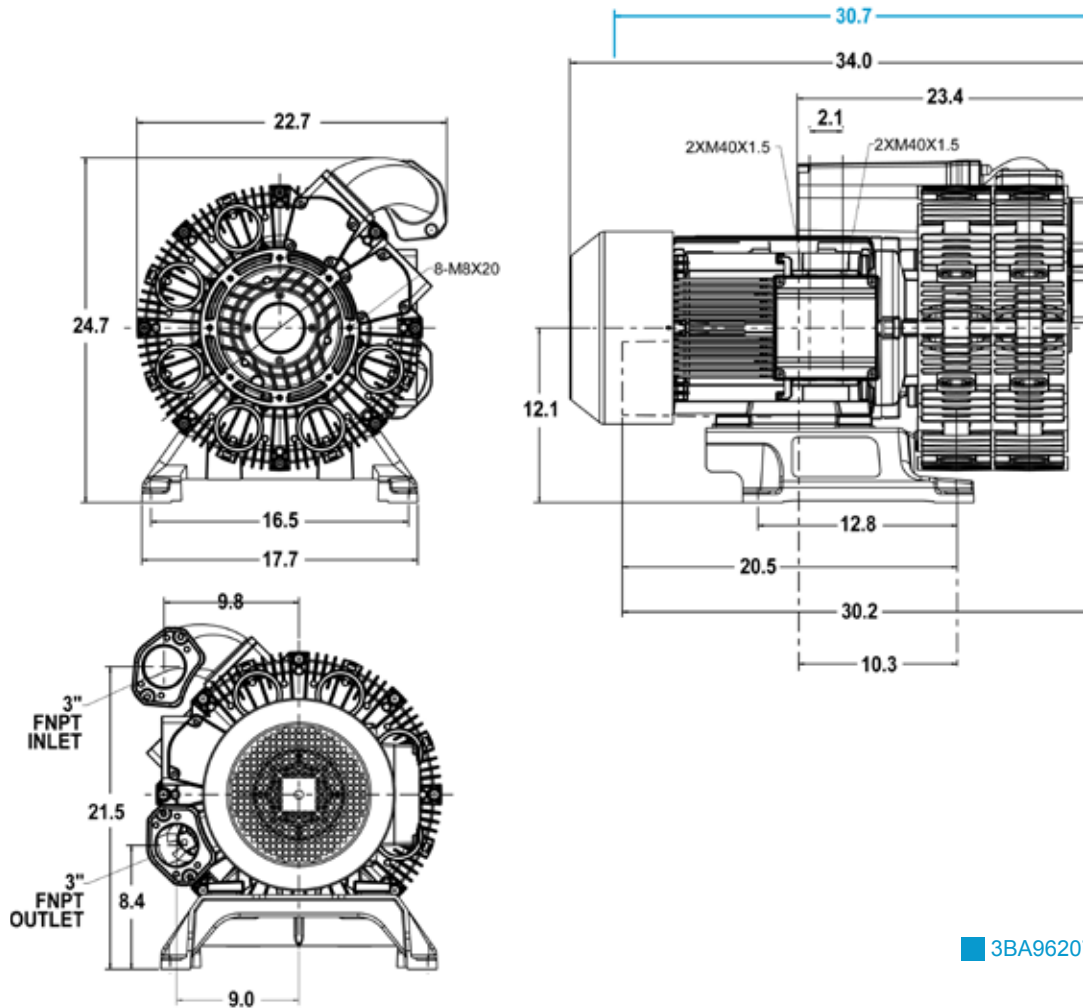

■ 3BA96207AT66

Selection & Ordering Data - Type 3BA9620

| Curve Letter | Order Number | Frequency (Hz) | Rated Power (HP) | Input Voltage (V) | | Input Current (A) | Permissible Total Differential Pressure | | Sound Level dB(A) | Weight (lbs) |
|---|--------------|----------------|------------------|-------------------|-------------|-------------------|---|-------------------|-------------------|--------------|
| | | | | | | | Vacuum Inch H2O | Pressure Inch H2O | | |
| 1~50/60 IP155 insulation material class F | | | | | | | | | | |
| I | 3BA96207AT66 | 50 | 14.75 | 200D...240D | 345Y...415Y | 38.0D/22.0Y | -212 | 253 | 70 | 320 |
| I | 3BA96207AT66 | 60 | 16.90 | 220D...250D | 415Y...460Y | 38.0D/22.0Y | -217 | 212 | 74 | 320 |
| I | 3BA96207AT66 | 87 | 25.50 | 345D...415D | | 39.5D | -204 | 120 | 84 | 320 |
| J | 3BA96207AT86 | 50 | 20.10 | 200D...240D | 345Y...415Y | 53.0D/31.0Y | -212 | 357 | 70 | 370 |
| J | 3BA96207AT86 | 60 | 23.20 | 220D...250D | 415Y...460Y | 53.0D/30.5Y | -217 | 325 | 74 | 370 |
| J | 3BA96207AT86 | 87 | 34.80 | 345D...415D | | 51.5D | -204 | 253 | 84 | 370 |