

Features:

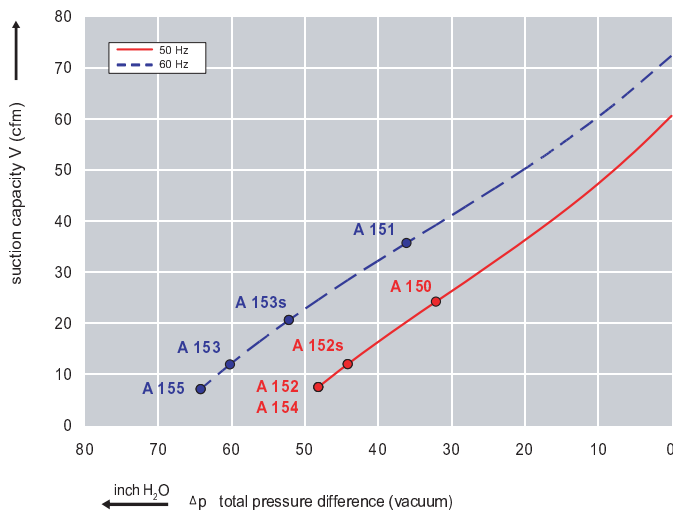

- Cooler running, outboard bearing provides maintenance-free operation
- Environmentally friendly oil-free technology
- Extremely quiet operation
- All motors are standard TEFC with Class F insulation, UL recognized, CE Compliant
Explosion-Proof motors available
- Custom construction blowers are available
- Rugged die cast aluminum construction

Performance curve for Vacuum pump



Performance curve for Compressor

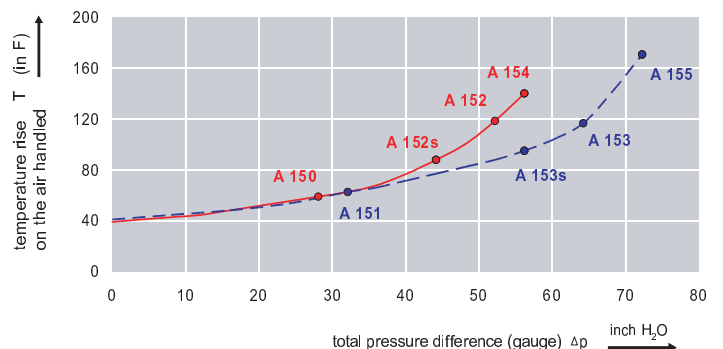
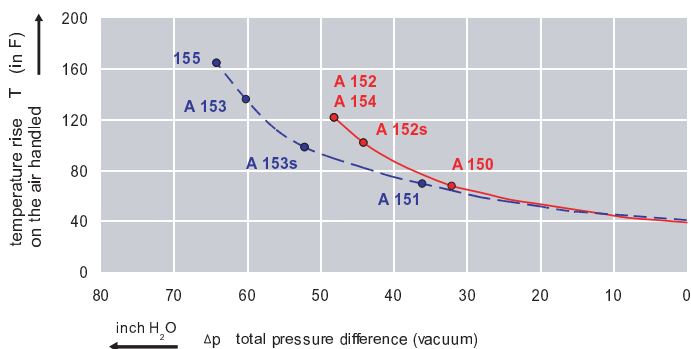
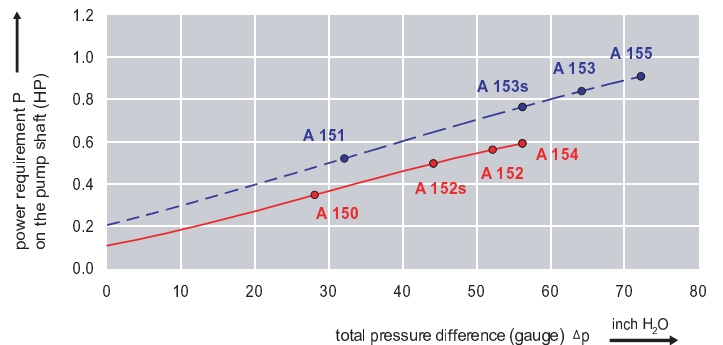
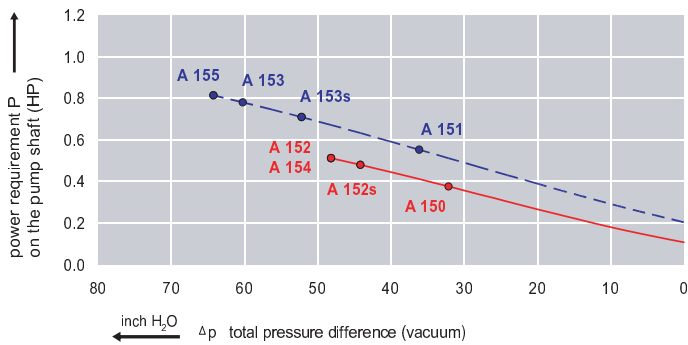
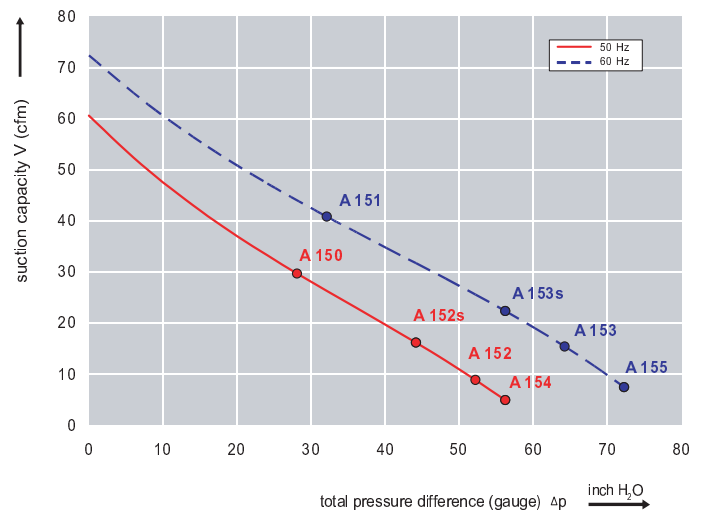

Dimensions: (inches)

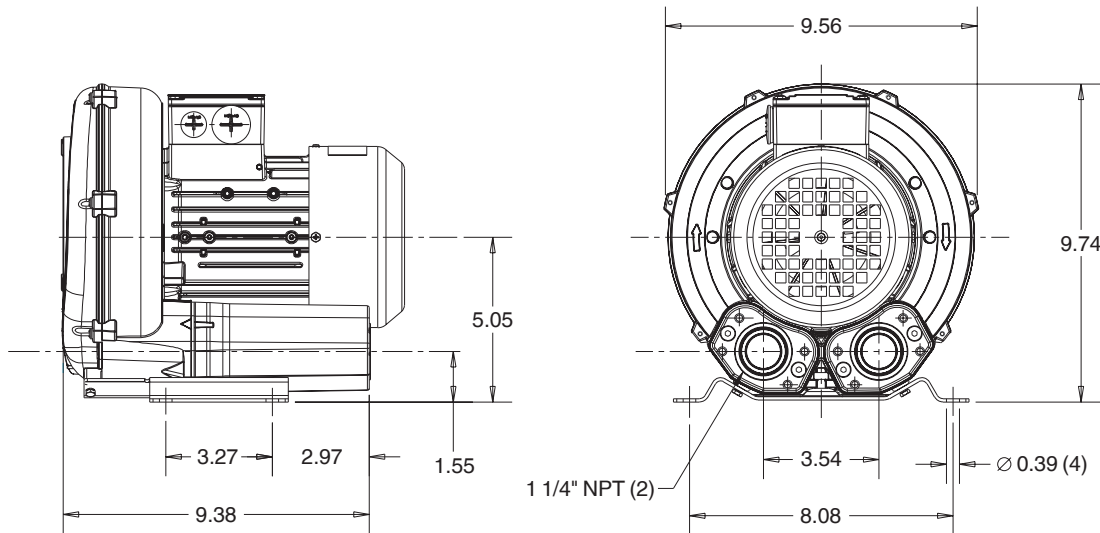

Recommended Accessories:

Relief valve:

VC51Z (Vacuum)
PC51Z (Pressure)

Filter:

ATF-125-1337
(Vacuum)
AFS-20-125-10
(Pressure)

Specifications subject to change without notice. Please contact factory for specification updates.

Selection & Ordering Data - Type 3BA1330

Curve No.	Order No.	Fre- quency Hz	Rated power HP	Input voltage		Input current A	Permissible total differential pressure ²⁾		Sound pressure level ³⁾ dB(A)	Weight ca. lbs	
				V			Vacuum inch H2O	Compressor inch H2O			
3~ 50/60 Hz IP55 insulation material class F											
A 150	3BA1330-7AT06	50	0.34	200D ... 240D	345Y ... 415Y	2.1 D	1.2 Y	-32	28	54	23
A 151	3BA1330-7AT06	60	0.39	220D ... 250D	415Y ... 460Y	1.74D	1.0 Y	-36	32	57	19
A 152	3BA1330-7AT16	50	0.54	200D ... 240D	345Y ... 415Y	2.6 D	1.5 Y	-48	52	54	23
A 153	3BA1330-7AT16	60	0.67	220D ... 250D	415Y ... 460Y	2.6 D	1.5 Y	-60	64	57	23
A 154	3BA1330-7AT26	50	0.94	200D ... 240D	345Y ... 415Y	3.8 D	2.2 Y	-48	56	54	25
A 155	3BA1330-7AT26	60	1.11	220D ... 250D	415Y ... 460Y	3.75D	2.15Y	-64	72	57	25
3~ 50/60 Hz IP55 insulation material class F											
A 150	3BA1330-7AT05	50	0.34	500D		0.72D		-32	28	54	23
A 151	3BA1330-7AT05	60	0.39	575D		0.76D		-36	32	57	19
A 152	3BA1330-7AT15	50	0.54	500D		1.0 D		-48	52	54	23
A 153	3BA1330-7AT15	60	0.67	575D		1.1 D		-60	64	57	23
A 154	3BA1330-7AT25	50	0.94	500D		1.88D		-48	56	54	25
A 155	3BA1330-7AT25	60	1.11	575D		1.76D		-64	72	57	25
1~ 50/60 Hz IP55 with attached capacitor for continuous operation											
A 152s	3BA1330-7AS15	50	0.50	115	230	5.4	2.7	-44	44	54	23
A 153s	3BA1330-7AS15	60	0.60	115	230	6.0	3.0	-52	56	57	23

Suitable for 208 Volt Operation

All curves are rated at 14.7 psia and 68° F ambient conditions and are reported in SCFM referenced to 68° F and 14.696 psia sea level conditions. Curve values are nominal, actual performance may vary by up to 10% of the values indicated. For inlet temperatures above approximately 80 °F or for handling gases other than air, please contact your Airtech sales representative for assistance.