

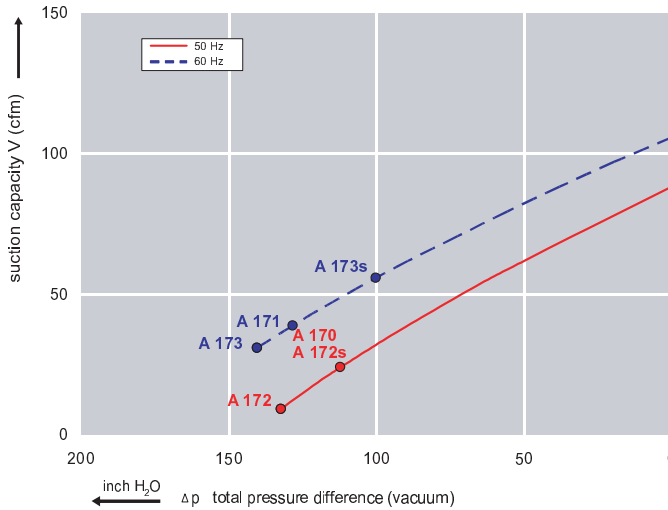

### Features:

- Cooler running, outboard bearing provides maintenance-free operation
- Environmentally friendly oil-free technology
- Extremely quiet operation
- All motors are standard TEFC with Class F insulation, UL recognized, CE Compliant  
*Explosion-Proof motors available*
- Custom construction blowers are available
- Rugged die cast aluminum construction

Performance curve for Vacuum pump



Performance curve for Compressor

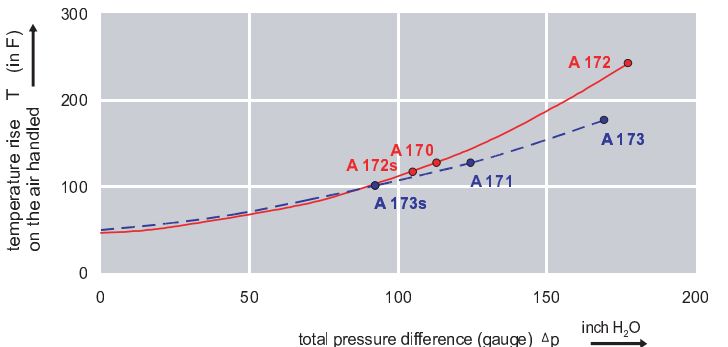
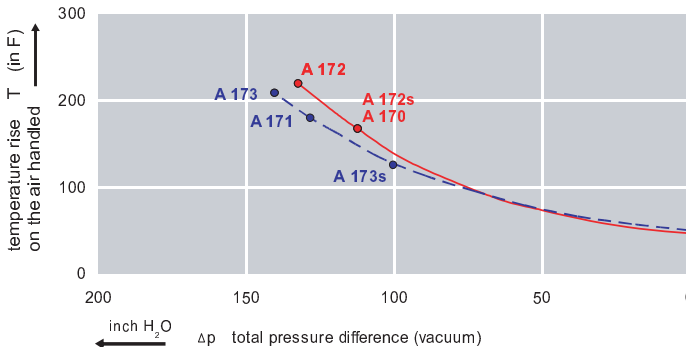
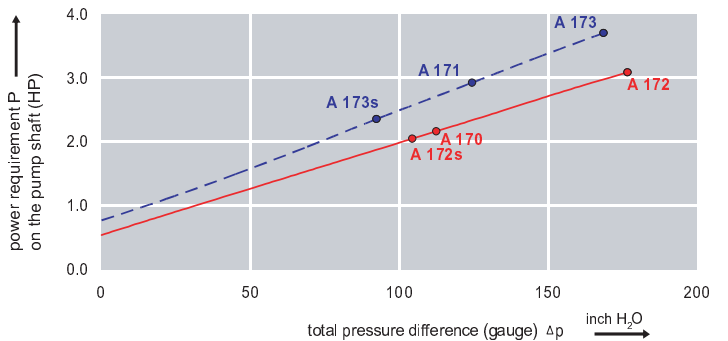
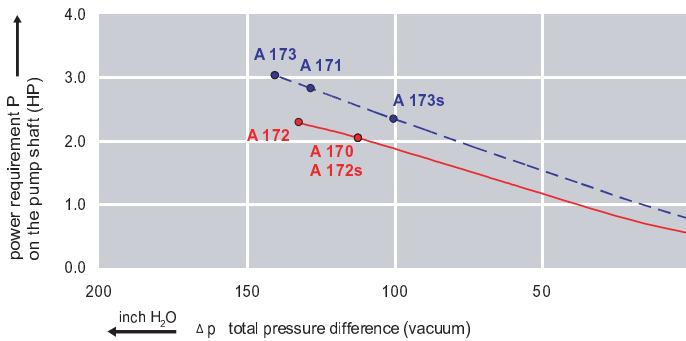
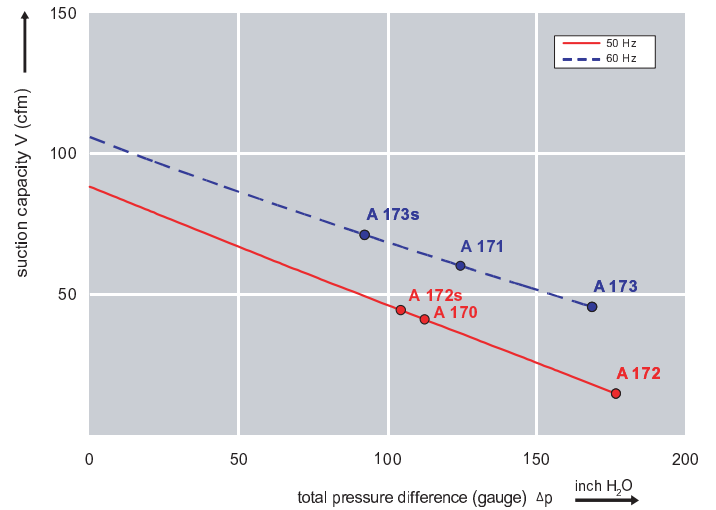

### Dimensions: (inches)

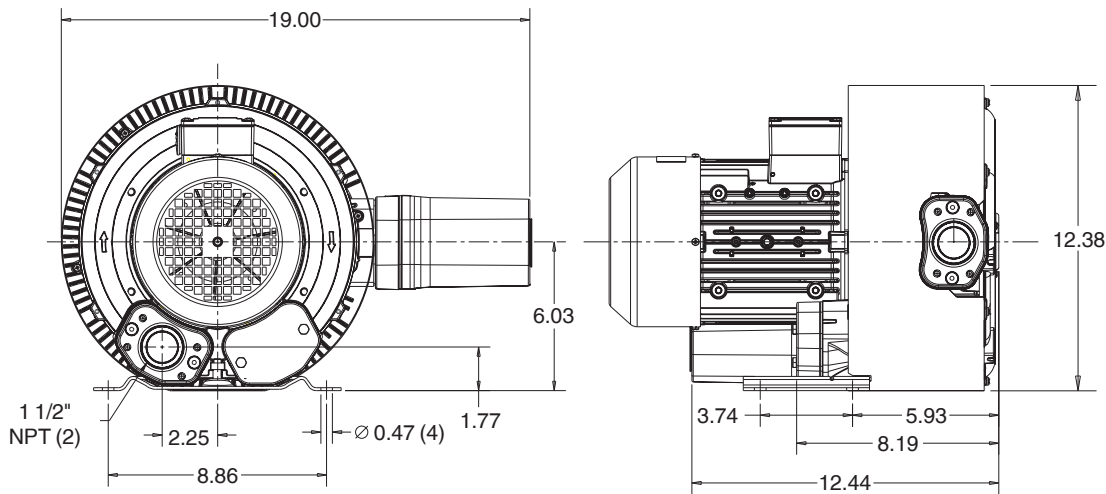

### Recommended Accessories:

#### Relief valve:

VC51Z (Vacuum)  
PC51Z (Pressure)

#### Filter:

ATF-150-1337 (Vacuum)  
AFS-20-150-10 (Pressure)

Specifications subject to change without notice. Please contact factory for specification updates.

### Selection & Ordering Data - Type 3BA1410

Curve No.	Order No.	Fre- quency Hz	Rated power HP	Input voltage		Input current		Permissible total differential pressure		Sound pressure dB(A)	Weight lbs
				V		A		Vacuum inch H2O	Compressor inch H2O		
<b>3~ 50/60 Hz IP55 insulation material class F</b>											
A 170	3BA1410-7AT36	50	2.1	200D ... 240D	345Y ... 415Y	7.5D	4.3Y	-112	112	66	53
A 171	3BA1410-7AT36	60	2.75	220D ... 250D	415Y ... 460Y	7.5D	4.4Y	-128	124	69	53
A 172	3BA1410-7AT46	50	2.95	200D ... 240D	345Y ... 415Y	9.7D	5.6Y	-132	177	66	59
A 173	3BA1410-7AT46	60	3.42	220D ... 250D	415Y ... 460Y	9.0D	5.3Y	-141	169	69	59
<b>1~ 50/60 Hz IP55 with attached capacitor for continuous operation</b>											
A 172s	3BA1410-7AS45	50	2.0	115	230	22	11	-112	104	66	59
A 173s	3BA1410-7AS45	60	2.35	115	230	24	12	-100	92	69	59

Suitable for 208 Volt Operation

All curves are rated at 14.7 psia and 68° F ambient conditions and are reported in SCFM referenced to 68° F and 14.696 psia sea level conditions. Curve values are nominal, actual performance may vary by up to 10% of the values indicated. For inlet temperatures above approximately 80 °F or for handling gases other than air, please contact your Airtech sales representative for assistance.