

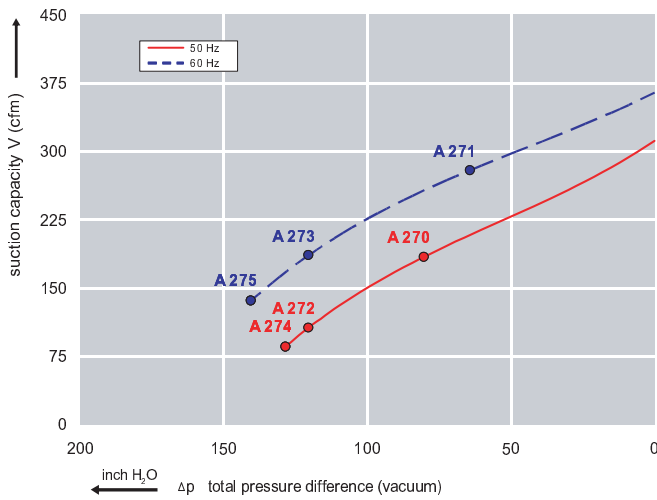

Features:

- Cooler running, outboard bearing provides maintenance-free operation
- Environmentally friendly oil-free technology
- Extremely quiet operation
- All motors are standard TEFC with Class F insulation, UL recognized, CE Compliant
Explosion-Proof motors available
- Custom construction blowers are available
- Rugged die cast aluminum construction

Performance curve for Vacuum pump



Performance curve for Compressor

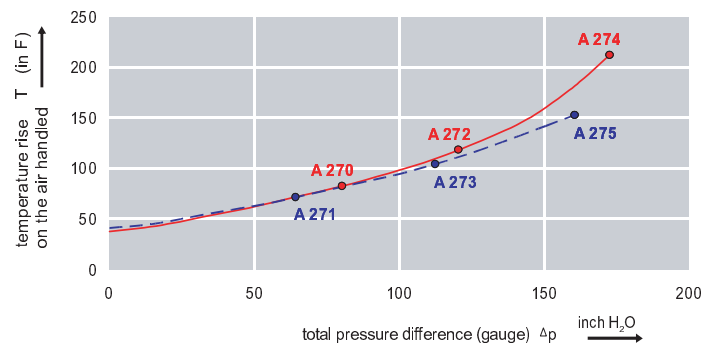
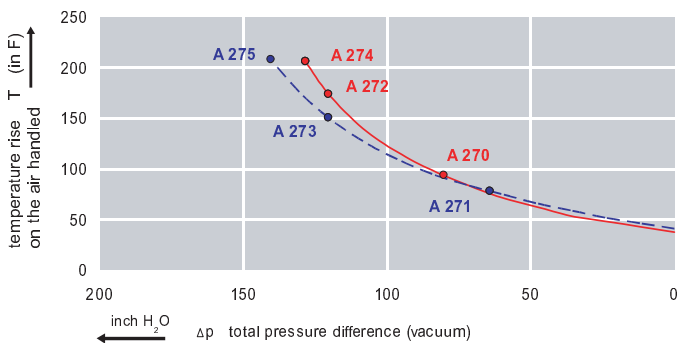
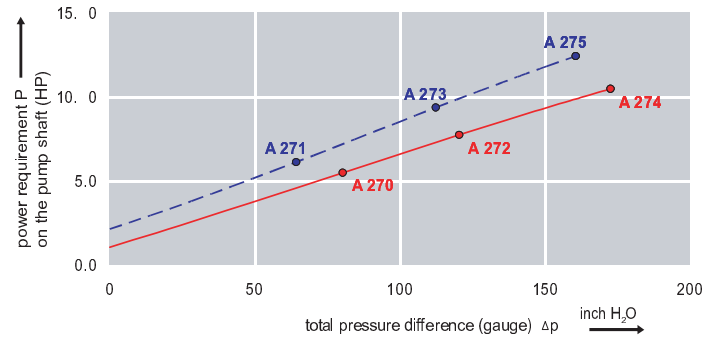
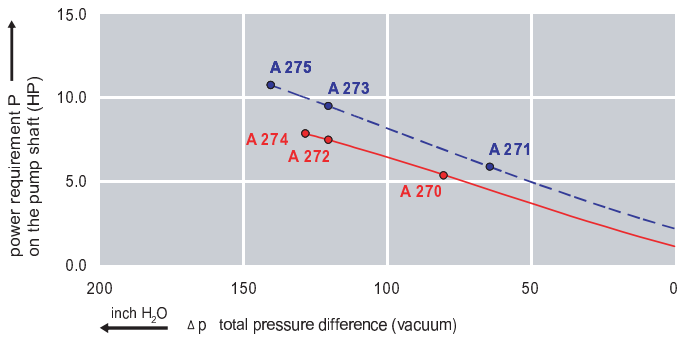
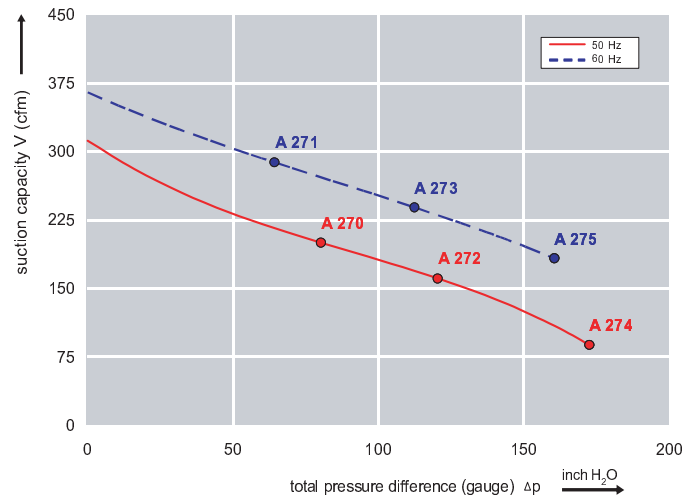

Dimensions: (inches)

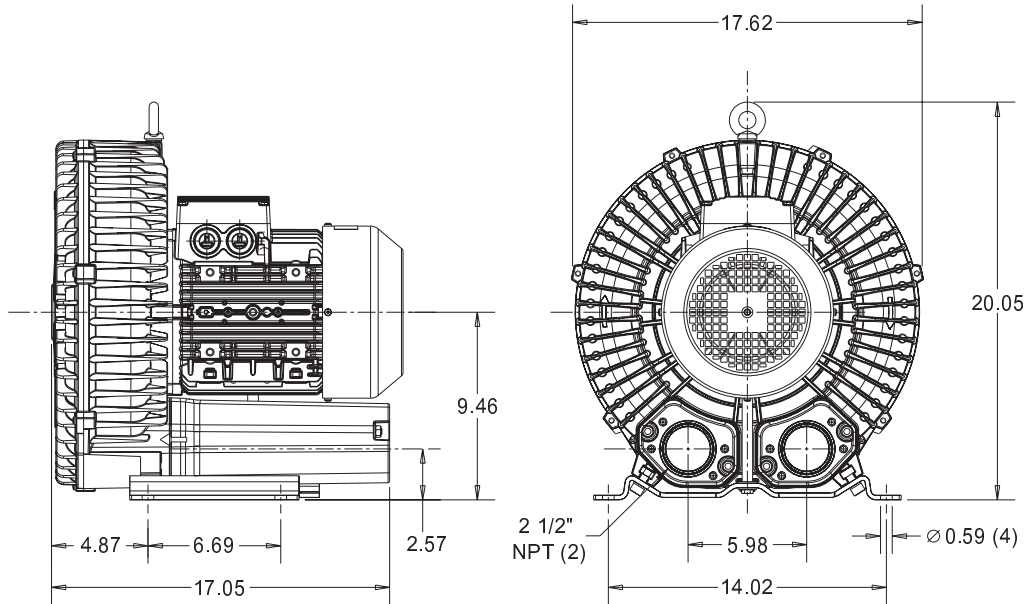

Recommended Accessories:

Relief valve:

VC81Z (Vacuum)
PC81Z (Pressure)

Filter:

ATF-250-15124/1
(Vacuum)
AFS-230-250-10
(Pressure)

Specifications subject to change without notice. Please contact factory for specification updates.

Selection & Ordering Data - Type 3BA1800

Curve No.	Order No.	Fre- quency Hz	Rated power HP	Input Voltage V	Input Current A	Permissible total differential pressure		Sound pressure level	lbs		
						Vacuum inch H2O	Compressor inch H2O				
3~ 50/60 Hz IP55 insulation material class F											
A 270	3BA1800-7AT06	50	5.36	200D ... 240D	345Y ... 415Y	15.6D	9.0Y	-80	80	70	128
A 271	3BA1800-7AT06	60	6.16	220D ... 250D	415Y ... 460Y	15.2D	8.5Y	-64	64	74	128
A 272	3BA1800-7AT16	50	7.37	200D ... 240D	345Y ... 415Y	23.0D	13.3Y	-120	120	70	143
A 273	3BA1800-7AT16	60	8.44	220D ... 250D	415Y ... 460Y	23.0D	13.3Y	-120	112	74	143
A 274	3BA1800-7AT26	50	10.05	200D ... 240D	345Y ... 415Y	29.0D	16.7Y	-128	173	70	150
A 275	3BA1800-7AT26	60	11.52	220D ... 250D	415Y ... 460Y	27.5D	15.0Y	-141	161	74	150

Suitable for 208 Volt Operation

All curves are rated at 14.7 psia and 68°F ambient conditions and are reported in SCFM referenced to 68°F and 14.696 psia sea level conditions. Curve values are nominal, actual performance may vary by up to 10% of the values indicated. For inlet temperatures above approximately 80 °F or for handling gases other than air, please contact your Airtech sales representative for assistance.