

Features:

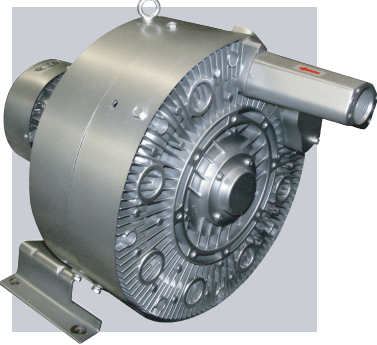

- Cooler running, outboard bearing provides maintenance-free operation
- Environmentally friendly oil-free technology
- Extremely quiet operation
- All motors are standard TEFC with Class F insulation, UL recognized, CE Compliant
Explosion-Proof motors available
- Custom construction blowers are available
- Rugged die cast aluminum construction

Performance curve for Vacuum pump

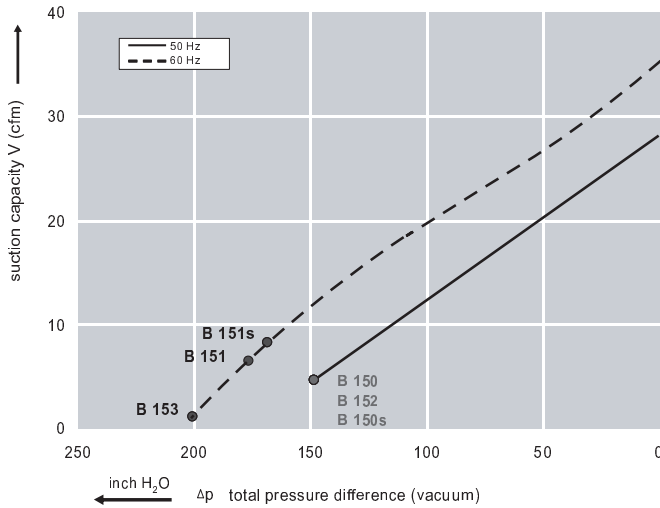

Performance curve for Compressor

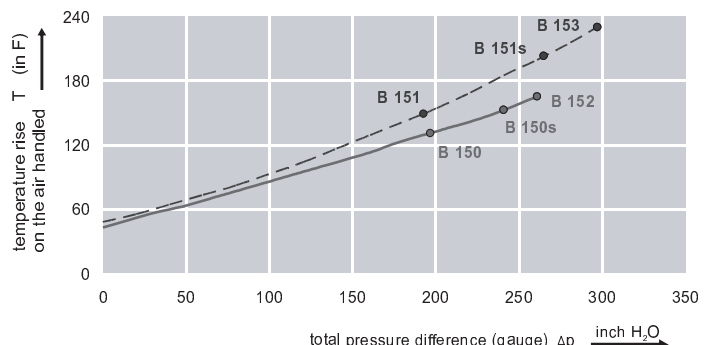
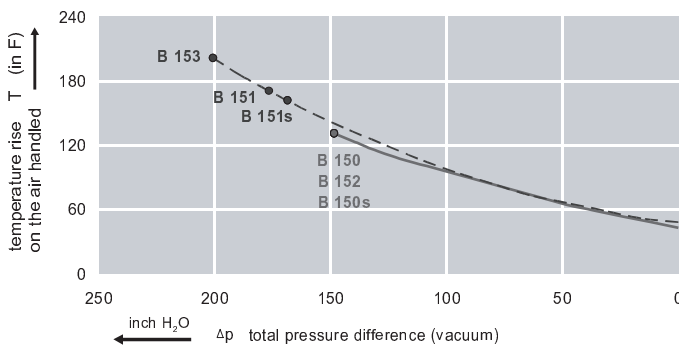
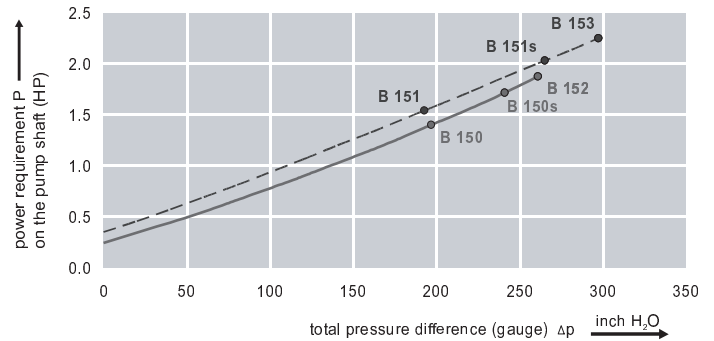
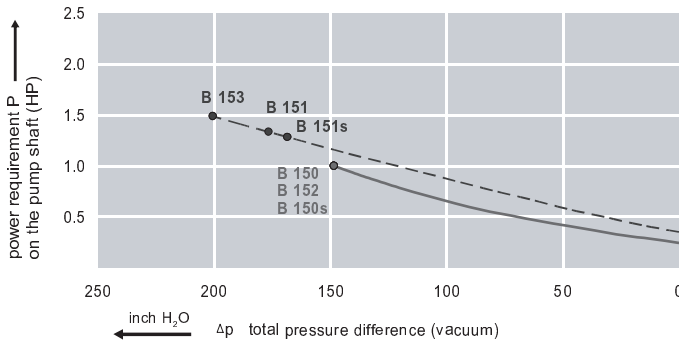
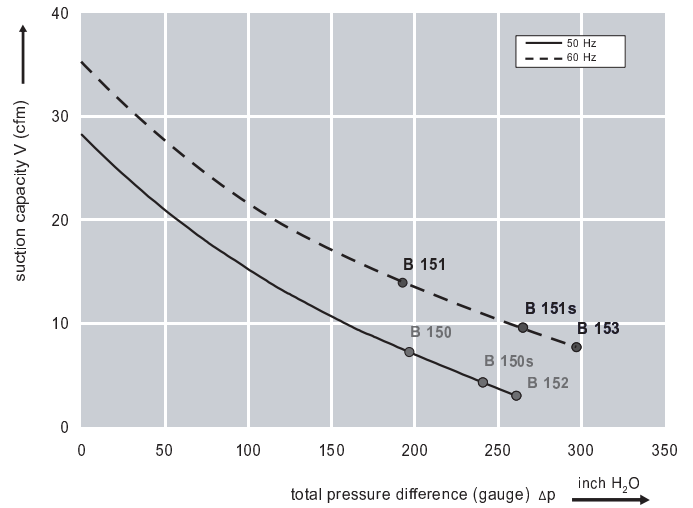

Dimensions: (inches)

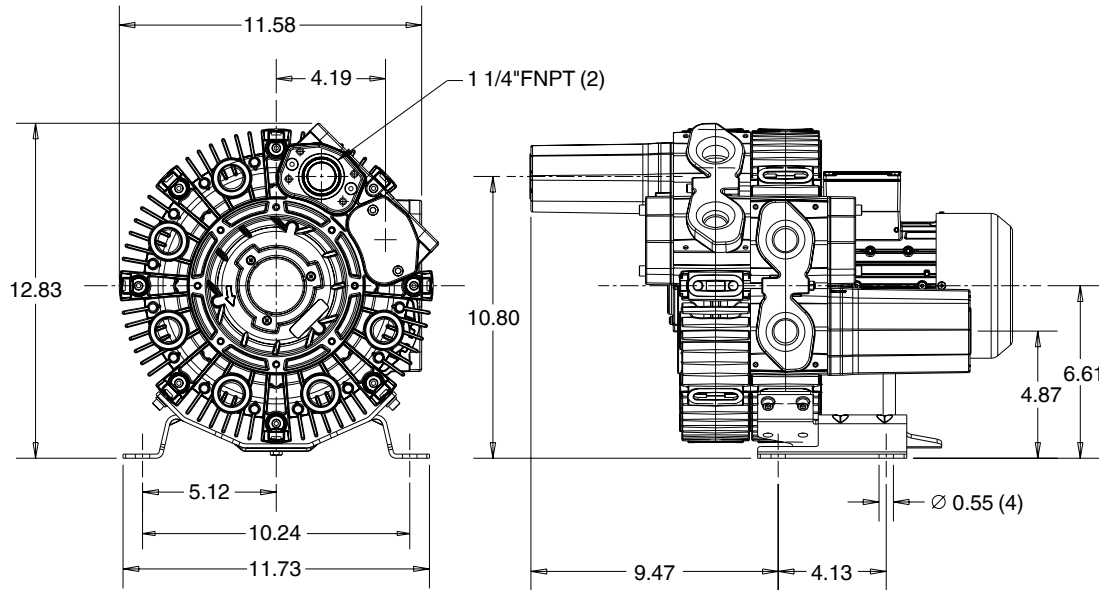

Recommended Accessories:

Relief valve:

VC51Z (Vacuum)
PC51Z (Pressure)

Filter:

ATF-125-1337
(Vacuum)
AFS-20-125-10
(Pressure)

Specifications subject to change without notice. Please contact factory for specification updates.

Selection & Ordering Data - Type 3BA7220

Curve No.	Order No.	Fre- quency Hz	Rated power HP	Input voltage		Input current		Permissible total differential pressure		Sound pressure level dB(A)	Weight lbs
				V		A		Vacuum inch H2O	Compressor inch H2O		
3~ 50/60 Hz IP55 insulation material class F											
B 150	3BA7220-0AT26	50	1.09	200D ... 240D	345Y ... 415Y	4.0D	2.3 Y	-149	197	58	53
B 151	3BA7220-0AT26	60	1.26	220D ... 250D	415Y ... 460Y	4.0D	2.3 Y	-177	193	62	53
B 152	3BA7220-0AT56	50	2.01	200D ... 240D	345Y ... 415Y	7.5D	4.3 Y	-149	261	58	62
B 153	3BA7220-0AT56	60	2.75	220D ... 250D	415Y ... 460Y	7.5D	4.4 Y	-201	297	62	62
1~ 50/60 Hz IP55 with attached capacitor for continuous operation											
B 150s	3BA7220-0AS75	50	2.0	115	230	19.4	9.7	-149	241	58	66
B 151s	3BA7220-0AS75	60	2.35	115	230	20.6	10.3	-169	265	62	66

Suitable for 208 Volt Operation

All curves are rated at 14.7 psia and 68° F ambient conditions and are reported in SCFM referenced to 68° F and 14.696 psia sea level conditions. Curve values are nominal, actual performance may vary by up to 10% of the values indicated. For inlet temperatures above approximately 80 °F or for handling gases other than air, please contact your Airtech sales representative for assistance.